



20w 8" LED Panel Down Light with Built-in Driver

Product Features

- 20w
- 3 colours in one: 3000K, 4000K, 5000K (switch select)
- 100° Beam Angle
- Ø225 x 84mm
- 200mm cut-out
- IP54 (front only) protection
- 0.6m Flex cable and plug included
- Weight: 635g



3 Colour Adjustable



Specification Overview

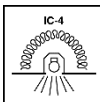

IP54
(front only)

Model	Power	Power Requirement	Colour Temp	Lumens	Beam Angle	Trim Colour	Dimensions
RDL-20200-3C-W	20w	220~240VAC	3000-4000-5000K	1820~2200lm	100°	White	Ø225x 84mm

Product Specification



20w 8" LED Panel Down Light with Built-in Driver

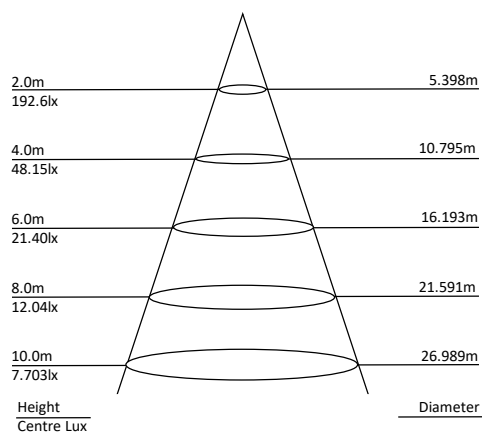
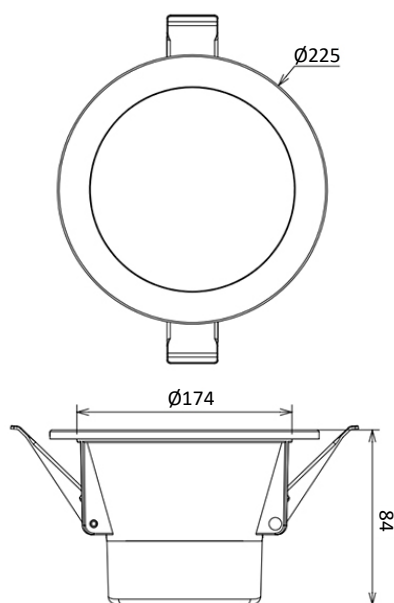

Specification

Model	RDL-20165-3C-W		
Colour Temperature (3CCT)	3000K	4000K	5000K
Lumen (lm)	1820	2200	1960
Efficiency (lm/w)	>91 lm/w		
Light Source	LED		
CRI (%)	≥80		
Beam Angle	100°		
Power Requirement	220~240VAC		
Power Consumption	20w		
Dimmable	Yes, Triac dimmable		
Housing	Plastic coated aluminium		
Lifespan	>40,000 hours		
Operation Temperature	-20°C~+45°C		
Product Dimension	Ø225 x 84mm		
Cut-Out	200mm		
Weight	635g		
Protection Rating	IP54 (front) / IP40 (rear)		
Warranty	3 Years		

Specifications are subject to change without notice