



## 400w V19E Slimline LED Flood Light

### Product Features

- 400w
- Quality Driver
- Full range power input 90~305VAC
- Aluminium die cast housing
- Tempered glass face
- 90° Beam Angle
- 503 x 545 x 64mm
- IP66 Housing
- Weight: 10.1kg



### Specification Overview

Model	Power	Power Requirement	Colour Temp	Lumens	Beam Angle	Trim Colour	Dimensions
FLA-SC400W-V19E	400w	90~305VAC	5000K	52,724lm	90°	Black	503x545x64mm

# Product Specification



## 400w V19E Slimline LED Flood Light

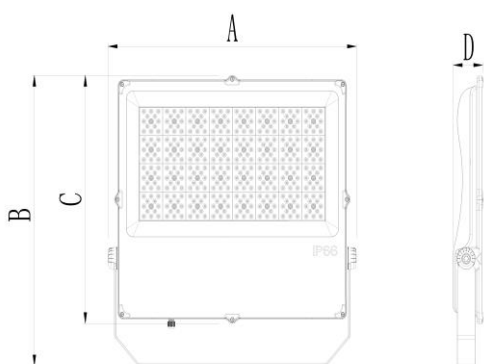

### Specification

Model	FLA-SC400W-V19E
Colour Temperature (1CCT)	5000K
Lumen (lm)	52,724lm
Efficiency (lm/w)	>132lm/w
Light Source	LED
CRI (%)	≥80
Beam Angle	90°
Power Requirement	90~305VAC
Power Consumption	396.8w
Dimmable	No
Housing	Diecast aluminium with toughened glass lens
Lifespan	>50,000 hours
Operation Temperature	-20°C~+60°C
Product Dimension	503 x 545 x 64mm
Impact Rating	IK08
Weight	10.1kg
Protection Rating	IP66
Warranty	5 Years

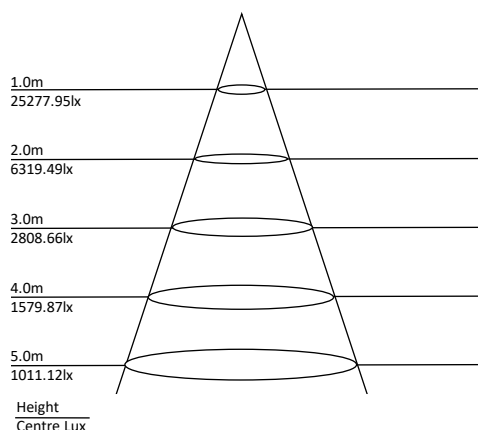

Specifications are subject to change without notice