



800w LED Stadium Flood Light

Product Features

- 800w
- Quality Driver
- Full range power input 90~305VAC
- Aluminium housing
- Polycarbonate lens face
- Choice of 15°, 30°, 40°x80°, 60° or 90°x135° Beam Angles
- 715 x 568 x 125mm
- IP66 Housing
- Weight: 25kg



Specification Overview

Model	Power	Power Requirement	Colour Temp	Lumens	Beam Angle	Trim Colour	Dimensions
ST-SF-800W	800w	90~305VAC	5000K	120000lm	See options	Black	715x568x125mm

Product Specification



800w LED Stadium Flood Light

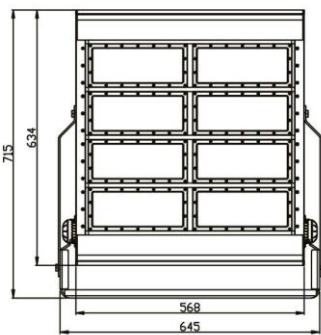
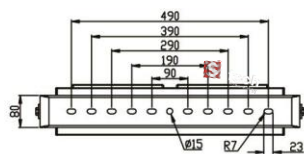

Specification

Model	ST-SF-800W
Colour Temperature (1CCT)	5000K
Lumen (lm)	120981lm
Efficiency (lm/w)	>151lm/w
Light Source	LED
CRI (%)	≥80
Beam Angle Options	15°, 30°, 40°x80°, 60° or 90°x135°
Power Requirement	90~305VAC
Power Consumption	798.54w
Dimmable	Optional (Dali, DMX or 0-10V)
Housing	Aluminium with polycarbonate lens
Lifespan	>50,000 hours
Operation Temperature	-40°C~+50°C
Product Dimension	715 x 568 x 125mm
Impact Rating	IK08
Weight	25kg
Protection Rating	IP66
Warranty	5 Years

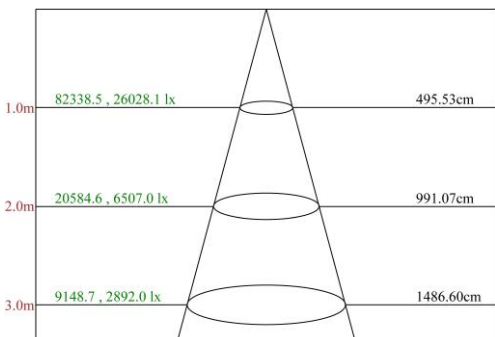

90° x 135° lens

Specifications are subject to change without notice