



## 30w LED/Solar G3 Integrated Street Light

### Product Features

- Inbuilt Motion Sensor
- Power saving mode (PSM) provides 30% reduced brightness until sensor detects motion
- Fits 60mm spigot size
- Supports pole top or spigot mount
- Automatic night-time operation
- MPPT intelligent controller
- Aluminium die cast housing
- Adjustable solar panel allows for ultimate angle and direction to achieve best charging results.
- 155/70° Beam Angle
- IP65 Housing
- Weight: 18.5kg



### Specification Overview

Model	Power	Power Requirement	Colour Temp	Lumens	Beam Angle	Trim Colour	Mounting Height	Dimensions	Spigot Size
SSL-G330C2	30w	Solar	5000K	3600lm	155/70°	Dark Grey	4-6m	Light 713 x 297 x 384mm Panel 343 x 623 x 192mm	Ø60mm

# Product Specification



## 30w LED/Solar G3 Integrated Street Light

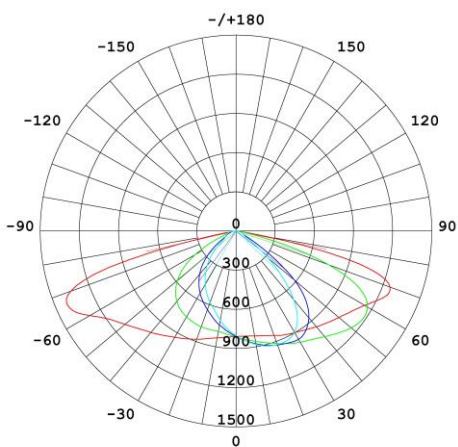
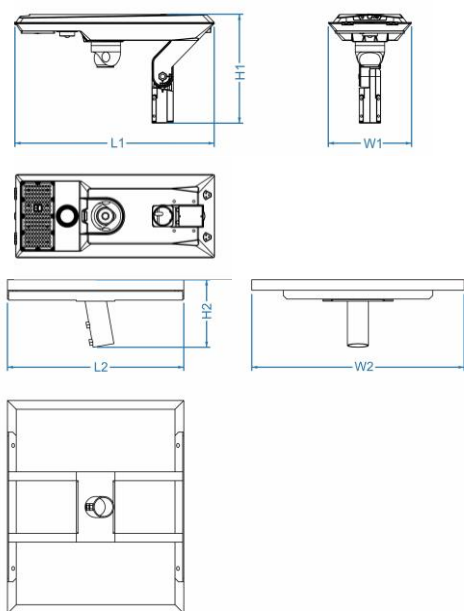

\* S-Tech solar products are designed for dusk to dawn operation with added allowance for winter conditions, however you must be aware that in winter months it is possible that some nights the light will not last all night due to inclement weather conditions limiting charging time. Solar is not recommended for any locations classed as critical lighting areas where lighting is required all night.

### Specification

Model	SSL-G330C2
Colour Temperature (1CCT)	5000K
Lumen (lm)	3600lm
Efficiency (lm/w)	>120lm/w
Light Source	LED
CRI (%)	≥80
Beam Angle	155° / 70°
Power Requirement	Solar Powered
Battery	178wH Ternary Lithium
Charging Time	~6 Hours
Operation Time	Dusk to dawn*
Factory Default Setting	30% no motion detected, 100% when motion detected
Housing	Diecast aluminium with PC diffuser
Lifespan	>40,000 hours
Operation Temperature	-10°C~+55°C
Product Dimension (light)	713 x 297 x 384mm
Product Dimension (panel)	343 x 623 x 192mm
Impact Rating	IK08
Weight	18.5kg
Protection Rating	IP65
Warranty	2 Years

Specifications are subject to change without notice

# Product Specification



## 30w LED/Solar G3 Integrated Street Light

### System Features



- Installation angle  $-15^\circ$  to  $+15^\circ$  adjustable
- Supports pole top or spigot mounting



- Die cast aluminium housing, tool-free opening for maintenance
- Corrosion resistant powder coating with S/Steel fixings

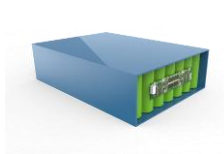

- Temperature protection system
- 3 way temperature control via battery, battery pack and system controller

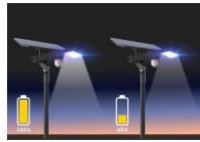

- MPPT controller, 15-20% higher efficiency than PWM controllers
- Low battery level dimming to prolong LED lighting time

### Installation methods

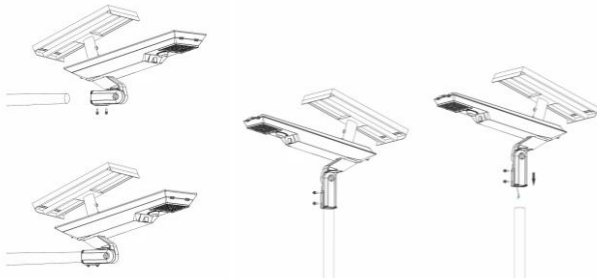

### A Guide to Spacing

Below is a quick guide to allow a calculation of the number of lights required for each type of application. This is to be used as a guide only however should you require your design to meet the AS/NZ standard then we highly recommend using a lighting designer to provide an approved design for your project.  
(Pedestrian path 1.5m wide, 4m high pole)

Pedestrian / Cycle Activity	Risk of Crime	Maintained Illuminance	Spacing in Metres
N/A	High	2 lux	26m
High	Medium	0.7 lux	34m
Medium	Low	0.3 lux	40m
Low	Low	0.14 lux	46m

### Brightness Control

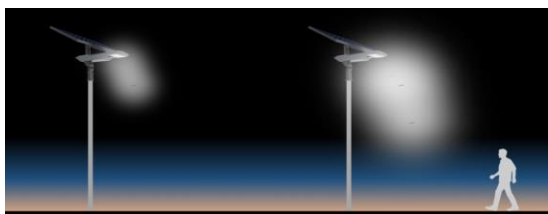

30% brightness when no movement

100% brightness when sensor activated

### Sensing Distance

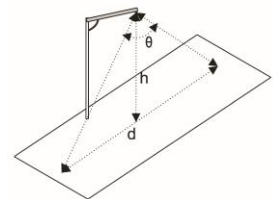

Inductive Type	$\theta$ (Angle)	h (Height of lamp rod)	d (Inductive width)
IR (infrared)	$60^\circ$	6-8m	6-10m